



## RECOIL PAD FITTING GUIDE INSTRUCTIONS

1. Find your make and model on the following pages of the Recoil Pad Fitting Guide to find the corresponding LimbSaver® Recoil Pad product number.
2. **IMPORTANT:** Due to manufacturers' stock deviations, LimbSaver® Precision-Fit Recoil Pads are not a guaranteed fit. **Please also use our templates to ensure proper fit.**
3. **Note:** All Precision-Fit and Grind-to-Fit® pads are designed for flat butt stocks (unless specified)
3. **Note:** All pads, unless specified, are approximately 1" in thickness.
4. **Note:** Precision-Fit pads are not intended to be ground.
5. The Precision-Fit Recoil Pad Fitting Guide is not an exhaustive list. If you do not find a match, please continue on to use our templates.

### COLOR KEY

- Synthetic Stocks
- Wood / Laminate Stocks (Flat Stocks)

# PRECISION-FIT RECOIL PAD FITTING GUIDE

LIMBSAVER®  
PRODUCTS THAT WORK

MAKE	MODEL	STOCK	AIRTECH®	CLASSIC
Benelli Benelli Benelli-Tactical Benelli-Tactical Benelli-Tactical Benelli	Sport 1, Sport II, Nova, SBE I, SBE II, Super Sport, MII, Cordoba 12/20ga <b>W/ Comfort-Tech Stock:</b> M2 21VR, Super Vinci <b>Pistol Grip Stock</b> Nova <b>Pistol Grip Stock w/ Pop-in Pad:</b> SBE MII (12ga), Super Sport, Super Sport, MII 12ga <b>Pistol Grip Stock Bolt-on Pad:</b> Super Sport Bolt-On, M1, SBE Black Eagle 12ga , 20ga Ultralight Satin Walnut with WeatherCoat™	Synthetic Synthetic Synthetic Synthetic Synthetic Wood	10810 10810    10810	10401 10401 10404 10404 10403 10401
Beretta Beretta Beretta Beretta	A300 Outlander, A400 Extreme, Extrema2 with Kick Off stock-12ga, TX4 Storm Sporting/Competition e.g. DT11-692 A300 Outlander, A400 Excel, 690 Sporting W/ Kick Off, 692 Sporting W/ Kick Off Sporting/Competition e.g. DT11-692	Synthetic Synthetic Wood Wood	10817 10811 10817 10811	10702 10701 10702 10701
Blackhawk	SpecOps Gen II, Axiom Ultra Light, Axiom Thumb Hole	Synthetic	10811	10701
Blaser Blaser	R8 (5/8" thick pad) R93 Professional Camo/Dark Green/Black Bolt on only (5/8" thick pad)	Synthetic Synthetic		10818 10012
Browning Browning Browning Browning Browning Browning Browning	Gold 12 * 20ga only, Silver Hunter 12ga, Silver 12/20 GA A-Bolt Stainless Stalker BPS 10ga. X-Bolt Rifles, AB3 (A-Bolt 3) Rifles BPS Upland 20ga BPS Upland 12ga X-Bolt Rifles, AB3 (A-Bolt 3) Rifles	Synthetic Synthetic Synthetic Synthetic Wood Wood Wood	10801   10814 10815 10801 10814	10008 10002 10301  10030 10002
Choate	ALL stocks that use the mark5 Spacer System	Synthetic	10812	
Christensen Arms	Carbon Summit Rifle, Carbon Classic Rifle	Synthetic	10805	10101
Colt	LE6920 Series, LE6920 Law Enforcement 30+1 223REM/5.56NATO , LE6940 Series (5/8"-thick Snap-On pad)	Synthetic		10019
DPMS	GII AP4 (5/8"-thick Snap-On pad)	Synthetic		10019
Franchi Franchi	Verimax 912 12ga Alcoine 12 ga	Synthetic Wood	10810 10800	10401 10001
Harrington/Richards Harrington/Richards Harrington/Richards	Handi-Rifle, Adult synthetic - Straight/ Monte Carlo SB2-988 Slug Hunter Ultra Slug Hunter (pad screw hole modification)	Synthetic Wood/Lam Wood	 10802 10816	10018 10003 10601
Knight	50cal. Disc Inline ML	Synthetic	10801	10002
Magpul Magpul Magpul Magpul	MOE-SL Carbine (5/8"-thick pad) ACS Mag 370/371, CTR Mag 310/311, ACS-L Mag 378/379 (5/8"-thick pad) MOE Mag 400/401, STR Mag 470/471, UBR Collapsible Stock Mag 330- Mil-Spec (5/8"-thick pad) SGA Stocks with the SGA with Adapter	Synthetic Synthetic Synthetic Synthetic	   10805	10829 10025 10025 10101



# PRECISION-FIT RECOIL PAD FITTING GUIDE

**LIMBSAVER®**  
PRODUCTS THAT WORK

MAKE	MODEL	STOCK	AIRTECH®	CLASSIC
Marlin	Model XS7	Synthetic	10805	10101
Mossberg	500A, 535, 695, 835, 590 A1, 590SP 12ga, 930 (NON SPX), 935 NON-Pistol Grip, 88 12ga	Synthetic	10809	10201
Mossberg	Maverick 88 20ga	Synthetic	10807	10111
Mossberg	ATI pistol grip non-tactical	Synthetic	10802	10003
Mossberg	MOE 590A1 with SGA Adapter	Synthetic	10805	10101
Mossberg	International™ 715T™, 500 - ATI Tactical (5/8"-thick Snap-On pad)	Synthetic		10019
Mossberg	All 4 7/8" buttstocks	Synthetic		10121
Remington	700 SPS, 700 ADL, 700 BDL, 700 ML, 710, 770, 870, 870 Express, 870 Express Tactical	Synthetic	10805	10101
Remington	1100 Competition, 1100 Tactical 12/22 OD-Green, 11-87, 7600, SP-10, VTR Centerfire	Synthetic	10805	10101
Remington	870 Magnum Special Purpose	Synthetic	10806	10102
Remington	700 LVSF, Titanium	Synthetic	10816	10601
Remington	750, 870 Wing Master (non-Express), 870 Police-12/18/20 ga, 1100 G3	Wood	10806	10102
Remington	Model 1187 SP 1992 yr - 35 Whelen	Wood	10806	10102
Remington	1187 4/7, 1100 2/5, 7 CDL, 673 guide gun, 700 DM	Wood	10808	10112
Ruger	American, American Magnum, American Predator, American LH	Synthetic	10825	
Ruger	American All Weather, American Crossfire, American Ranch	Synthetic	10825	
Ruger	American Compact, American All Weather Compact	Synthetic	10824	
Ruger	M77, Hawkeye	Synthetic	10800	10001
Ruger	77, Mark II, Factory Skeleton Stock-(Request Adapter from us)	Synthetic	10803	10011
Sako	75, Finnlight	Synthetic	10803	10011
Sako	75	Wood	10803	10011
Savage	93 R-AC-TR	Synthetic		10301
Savage	A17	Synthetic	10808	10112
Smith & Wesson	M&P®15T Tactical with M-LOK®, M&P®15 1 in 7" Twist (5/8"-thick Snap-On pad)	Synthetic		10019
Smith & Wesson	M&P® 15 Sport II 5.56 NATO 16" 30+1 (5/8"-thick Snap-On pad)	Synthetic		10019
Stag Arms	AR-15 Models 1, 1L, 2, 2L, 2T, 2TL, 3	Synthetic		10019
Stoeger	M3000, 3500	Synthetic	10823	
Stoeger	M2000 (No Pistol Grip), P-350 Pump	Synthetic		10008
Tapco	AK T6™ Stock, Mil-Spec Profile AR T6™ (5/8"-thick Snap-On pad)	Synthetic		10019
Tapco	INTRAFUSE T6 AK-47 Collapsible Stock for Stamped Receiver (5/8"-thick Snap-On pad)	Synthetic		10019
Thomp Ctr Arms	Triumph, Triumph Bone Collector, Pro Hunter, Pro Hunter Predator, Pro Hunter FX	Synthetic	10804	10031
Thomp Ctr Arms	Pro Hunter Turkey, Pro Hunter Shotgun Slug, Venture, Encore Pro Hunter	Synthetic	10804	10031
Thomp Ctr Arms	Omega ML, Black Diamond	Synthetic	10804	10031
Thomp Ctr Arms	Encore Pro Hunter, Omega ML, Black Diamond	Wood	10815	10030
Thomp Ctr Arms	Thunderhawk 50cal	Wood	10806	10102

# PRECISION-FIT RECOIL PAD FITTING GUIDE

**LIMBSAVER®**  
PRODUCTS THAT WORK

MAKE	MODEL	STOCK	AIRTECH®	CLASSIC
Tikka	T3X	Synthetic	10826	
Tikka	T3 Lite Adjustable, T3 Battue Lite Rifle 30.06, 9.3x62	Synthetic	10803	10011
Tikka	T3X	Wood	10826	
Tikka	T3 Lite - all models except T3 Sporter	Wood	10803	10011
Weatherby	PA-08 12ga	Synthetic	10807	10111
Winchester	Model 1300	Synthetic		10301
Winchester	Model 70 Super Shadow - 4 3/4"	Synthetic	10816	10601
Winchester	Model 12 Heavy Duck 12ga.	Wood	10808	10112

# GRIND-TO-FIT™ RECOIL PAD FITTING GUIDE

SIZE	MEASUREMENTS	CLASSIC	LOW PROFILE	NITRO	TRAP	SPEED MOUNT
Small	4 1/16" X 1 7/32" Grindable To: 3 1/8" X 1 1/32"	10541		10537	10534	
Medium	5 3/32" X 1 1/16" Grindable To: 4 1/4" X 1 1/16"	10542		10538	10535	
Medium Plus (Med +)	5 1/2" X 1 7/32" Grindable To: 3 7/32" X 1 1/32"		10544			10540
Large	5 5/16" X 2 1/16" Grindable To: 4 7/16" X 1 1/32"	10543		10539	10536	

# SLIP-ON RECOIL PAD FITTING GUIDE

SIZE	MEASUREMENTS	AIRTECH®	CLASSIC
Small	4 1/2" X 1 1/2" Up to 4 1/16" X 1 1/8"	10550	10546
Small/Medium	4 3/8" X 1 1/8" Up to 5 1/8" X 1 1/4" (1/2" thick)	10549	
Medium	4 1/16" X 1 1/8" Up to 5 1/8" X 1 3/4"	10551	10547
Large	5 1/8" X 1 1/4" Up to 5 3/8" X 1 1/4"	10552	10548



**PART #: 10001**(Classic),  
**10800**(AirTech)  
Template Dimensions:  
5.025" X 1.7"  
(Approx.) 5 - 1/32" X 1 - 11/16"

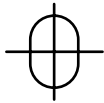
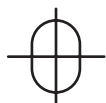

**PART #: 10002**(Classic),  
**10801**(AirTech)  
Template Dimensions:  
4.62" X 1.642"  
(Approx.) 4 - 5/8" X 1 - 5/8"

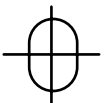
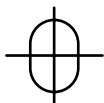

**Part #: 10003**(Classic),  
**10802**(AirTech)  
Template Dimensions:  
4.62" X 1.58"  
(Approx.) 4 - 5/8" X 1 - 9/16"

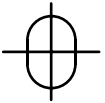
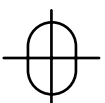

**PART #: 10011**(Classic),  
**10803**(AirTech)  
Template Dimensions:  
4.91" X 1.555"  
(Approx.) 4 - 29/32" X 1 - 9/16"

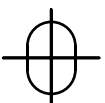

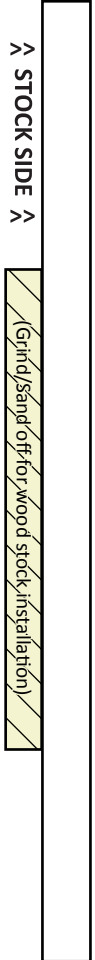
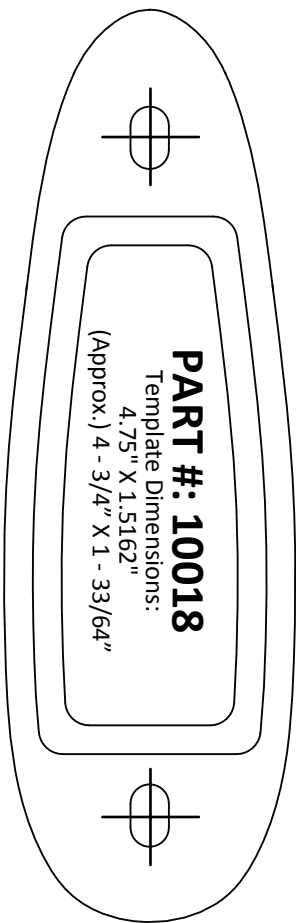
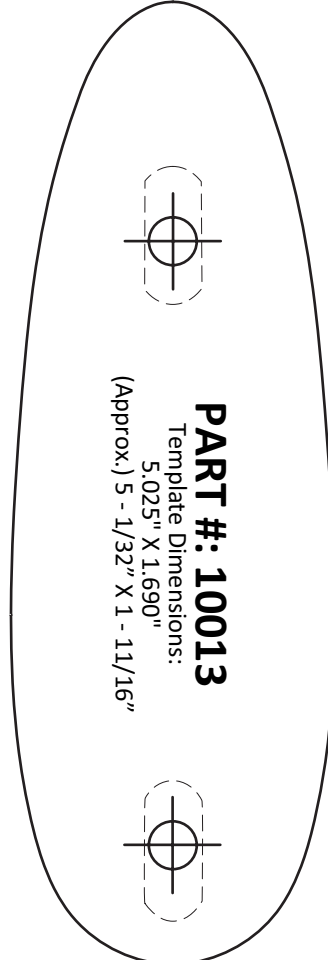
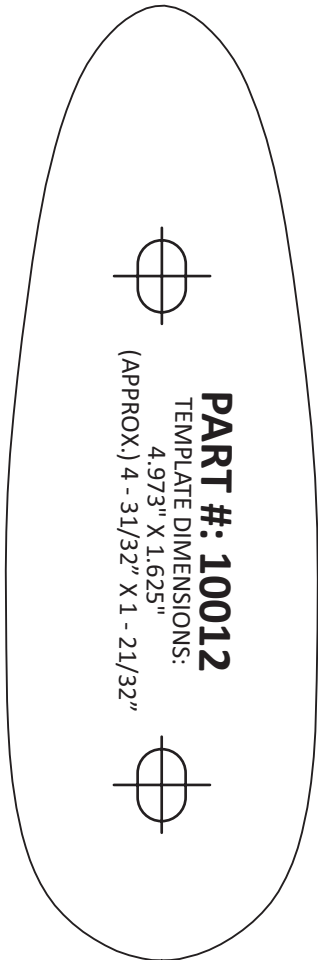



TACTICAL



**PART #: 10019, 10020**  
(AR-15 / M4 Snap-On)  
Template Dimensions:  
5.1875" X 1.875" (MAX)  
5-3/16" X 1-7/8" (Approx.)

AR-15 Universal 6-Position Tactical (1/4" step-down)  
Tapco T6, Colt LE6920, LE6940  
**SNAP-ON ONLY - No screw holes**

TACTICAL

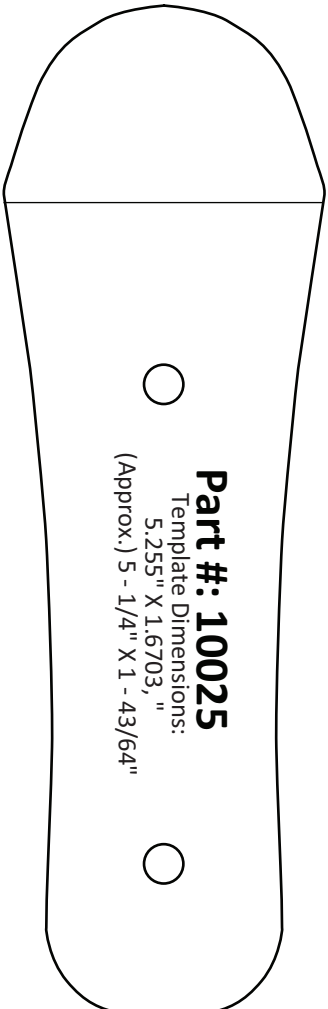

**Part #: 10025**  
Template Dimensions:  
5.255" X 1.6703,"  
(Approx.) 5 - 1/4" X 1 - 43/64"

Magpul STR, ACS, ACS-L, UBR, Mii Spec, CTR, MOE (MAG 310 & MAG 400)

TACTICAL

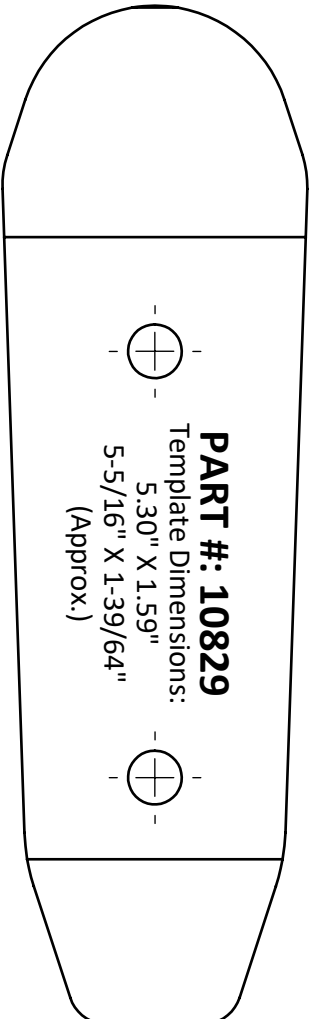

**PART #: 10829**  
Template Dimensions:  
5.30" X 1.59"  
5-5/16" X 1-39/64"  
(Approx.)

Magpul MOE SL stocks

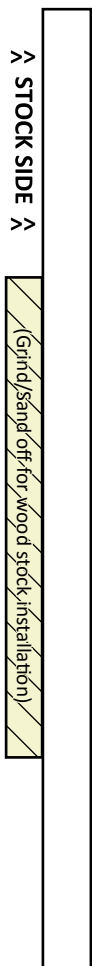
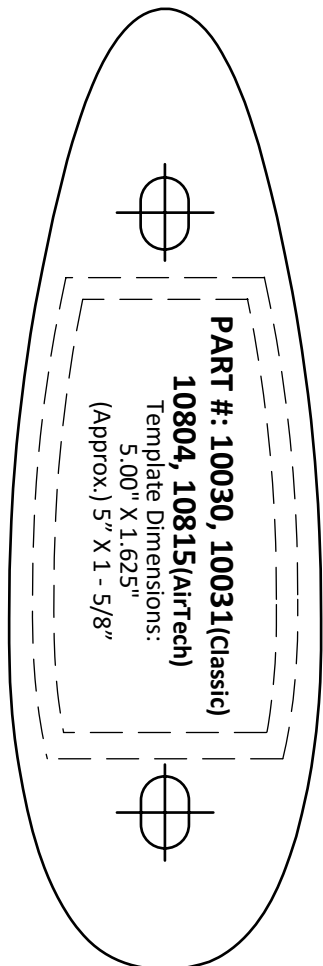

^ STOCK SIDE ^

10031/10815: for wood stocks only  
10031/10804: for synthetic stocks only

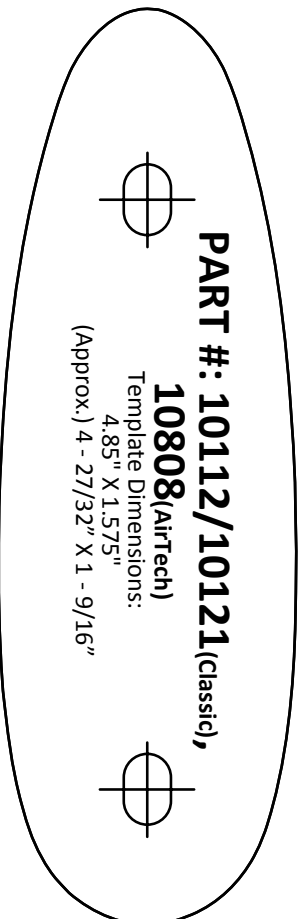
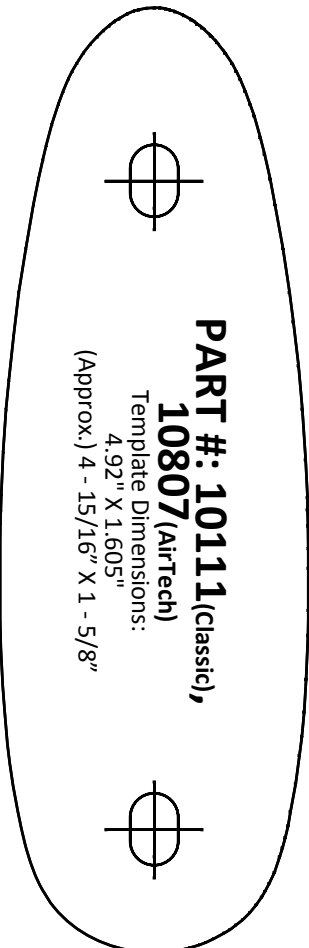



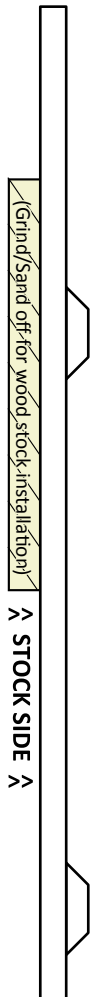
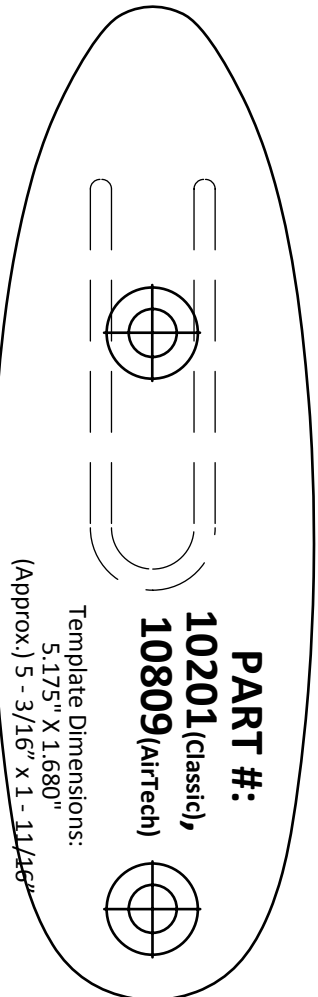

INCLUDES ADAPTER PIECE.

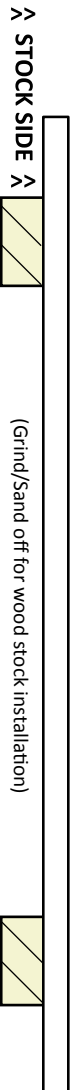
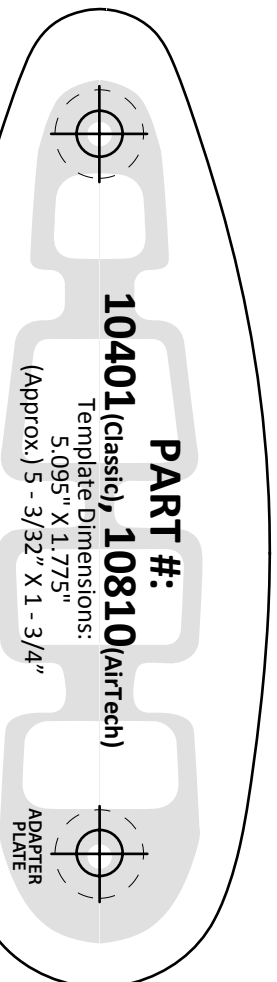
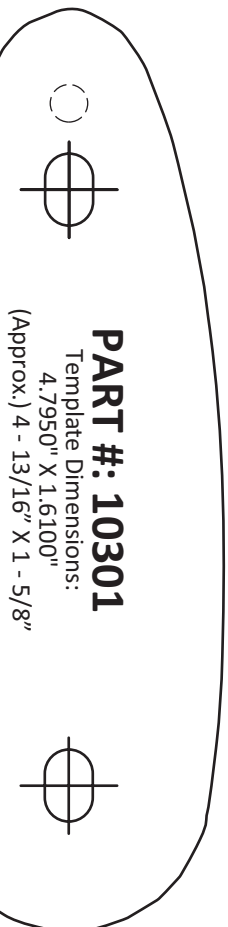



Benelli M1 Tactical, SBE II Study. Grip  
(Bolt-On)

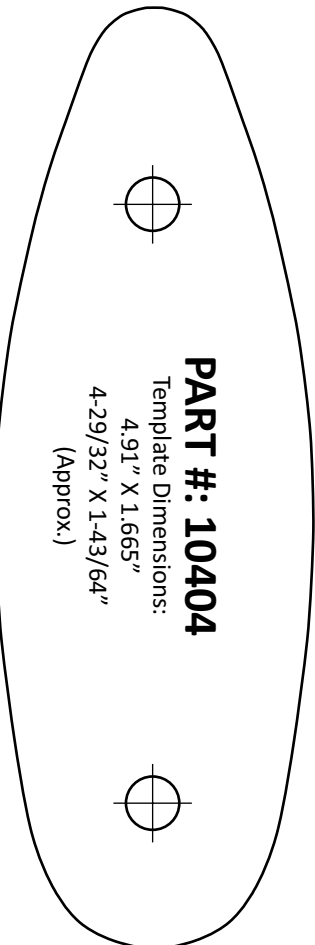

Benelli M2 Tactical, Supernova Tactical, SBE II Study. Grip  
(Snap On)  
INCLUDES ADAPTER PIECE.

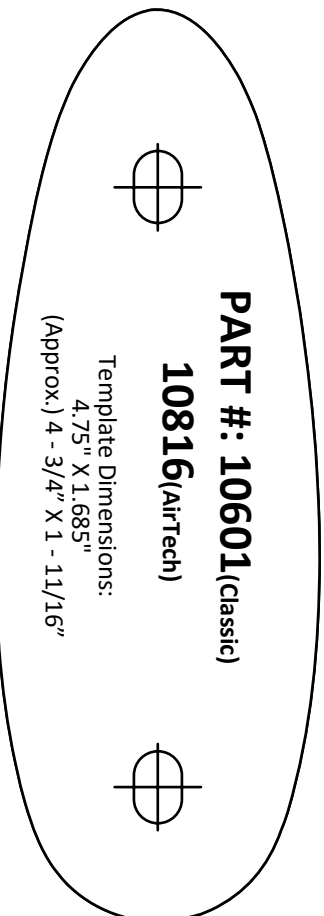

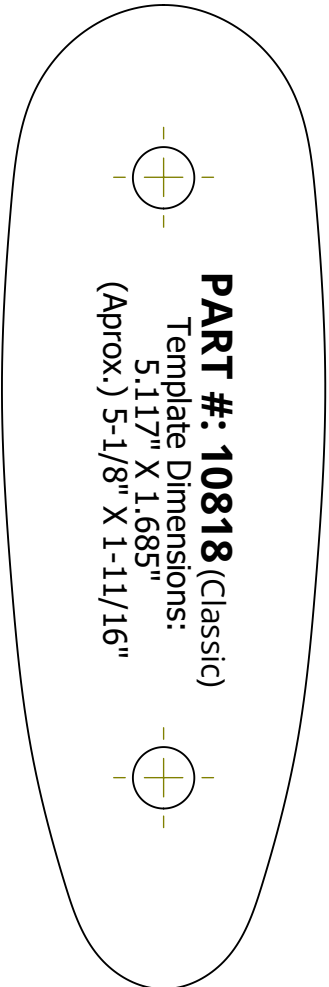
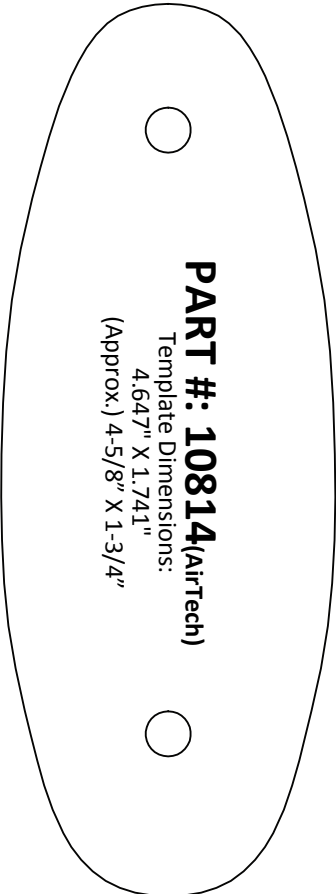
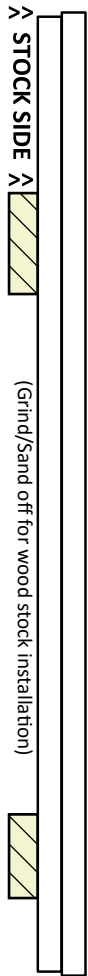
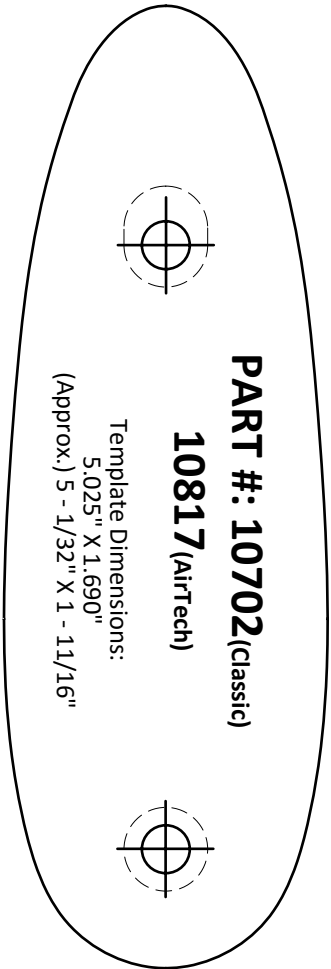



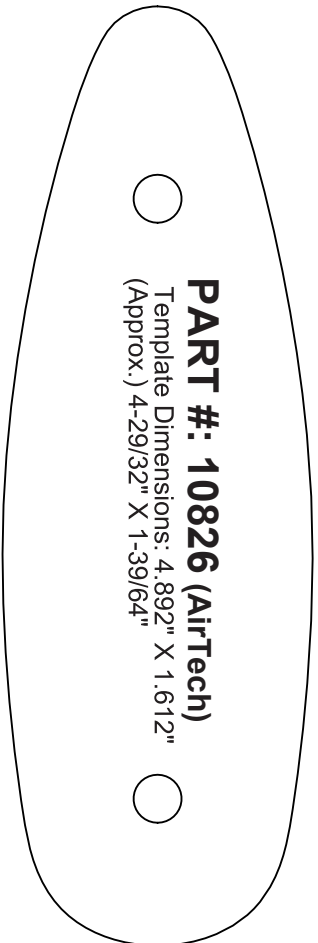
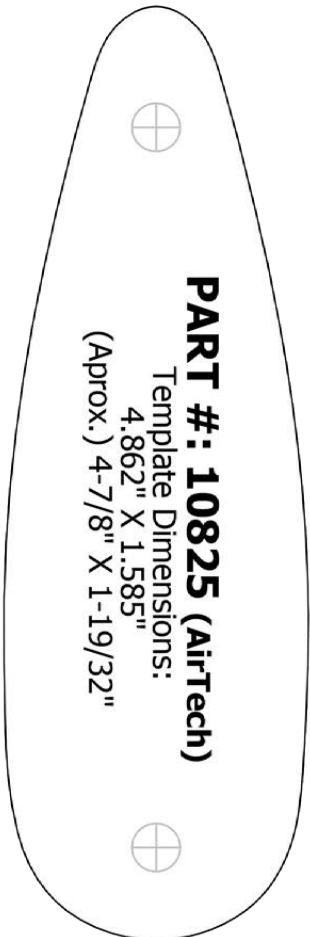
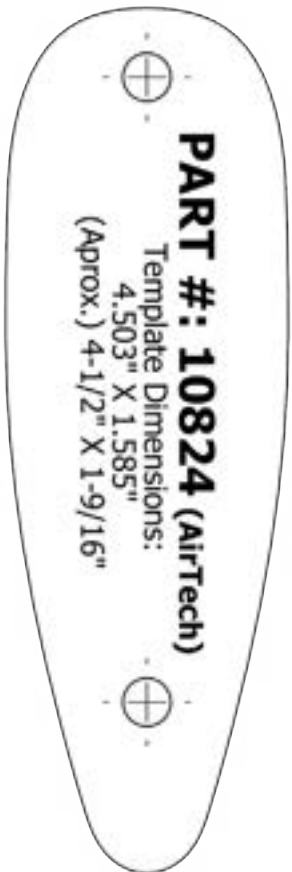

The following two templates on this page were designed to fit a specific make of synthetic stock. To accomplish as accurate a fit as possible, many of the synthetic recoil pad plates have profiles that snap inside the cavities of the stock. While most plates can be modified to fit a wood stock by grinding off any protruding plastic on the plate, the following two plates CANNOT be altered.

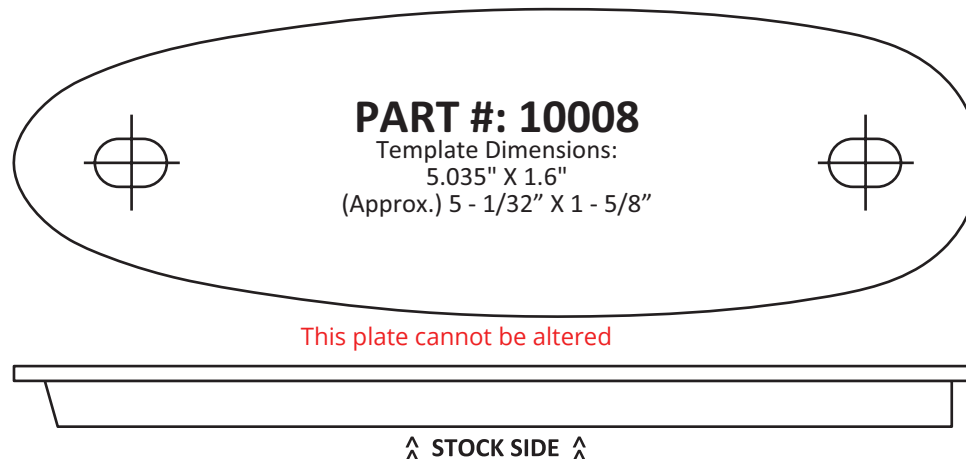

Browning Gold 12/20; Stoen M2000 (non-pistol grip & P-350 pump (syn.), Silver 12 GA. (Syn.)

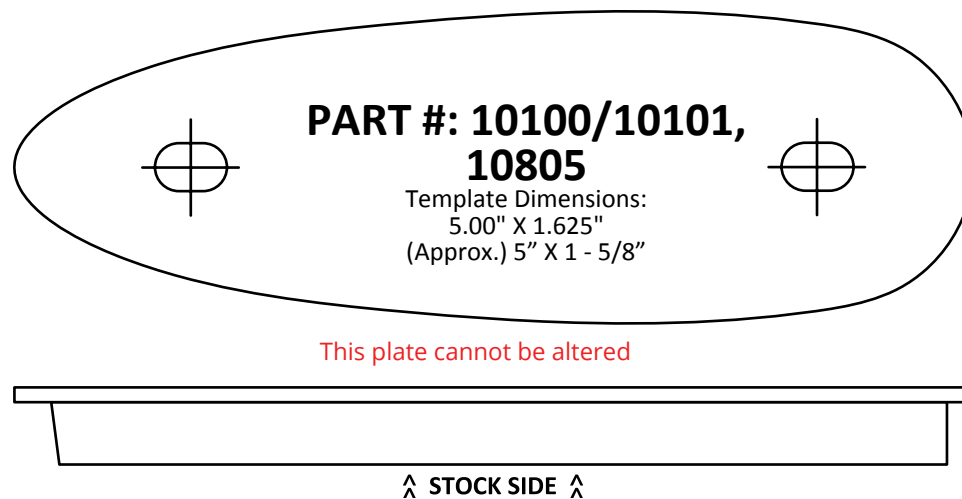

The following Grind-to-Fit Recoil Pads are shown with two profile lines. The outer line is the actual size of the pad. The inner line is the "Max" Grind line. In order for our technology to function properly, the interior air chamber must remain intact with enough wall thickness to contain the pressure during the firing of the weapon. By not grinding past this line, you ensure your pad will be in perfect working order. To determine which Grind-to-Fit Recoil Pad is right for you, remove your existing pad, and place your flat stock on the templates. Choose the pad that shows the full outer line of the template, and none of the interior line. For further instructions, see inside of our packaging, or go to [www.LimbSaver.com](http://www.LimbSaver.com).

### SMALL GRIND-TO-FIT



10541 is a Classic LimbSaver pad with 1" LOP  
10534 is a Trap LimbSaver pad with 1" LOP  
10537 is a Nitro LimbSaver pad with 1-1/2" LOP

### MEDIUM GRIND-TO-FIT

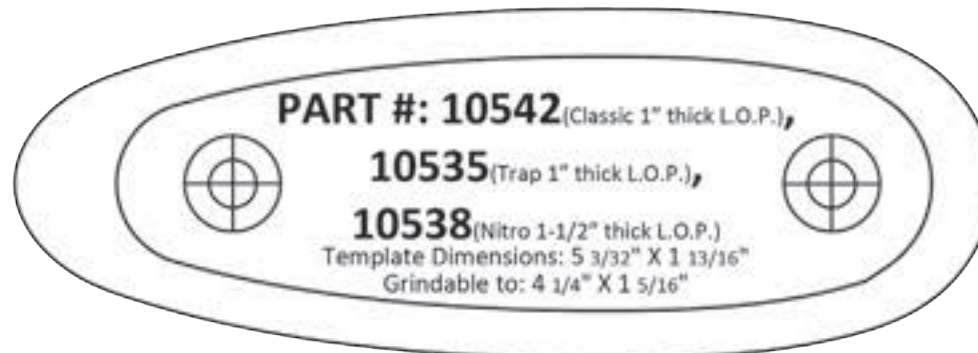

10542 is a Classic LimbSaver pad with 1" LOP  
10535 is a Trap LimbSaver pad with 1" LOP  
10538 is a Nitro LimbSaver pad with 1-1/2" LOP



### MEDIUM PLUS - GRIND-TO-FIT

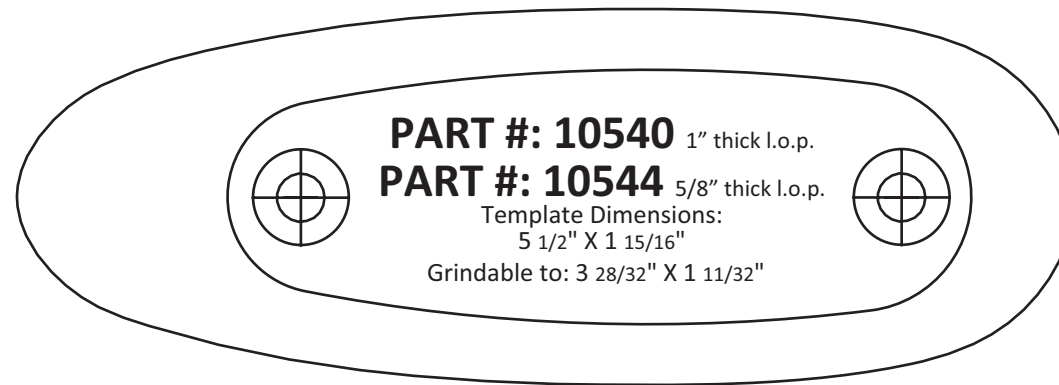

10540 is a Speed Mount LimbSaver pad with 1" LOP  
10544 is a Classic LimbSaver pad with 5/8" LOP

### LARGE GRIND-TO-FIT

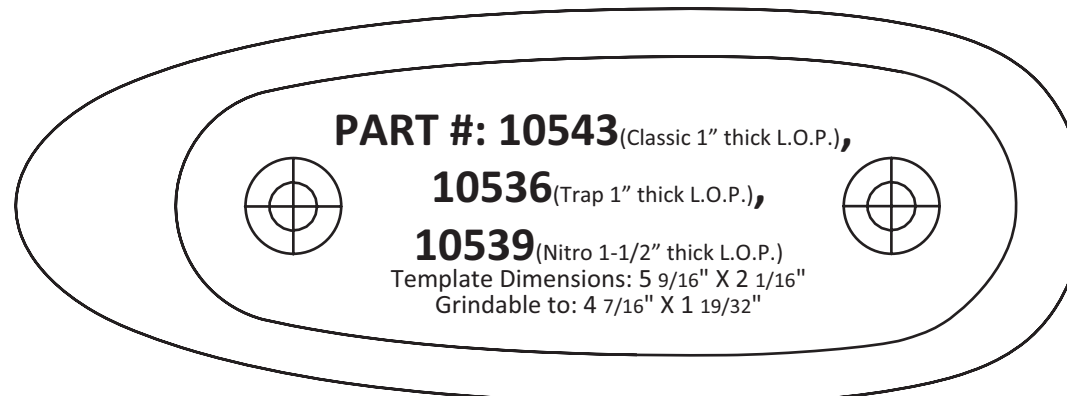

10543 is a Classic LimbSaver pad with 1" LOP  
10536 is a Trap LimbSaver pad with 1" LOP  
10539 is a Nitro LimbSaver pad with 1-1/2" LOP

**PRECISION - FIT**

